



SP240V200KA

Type 2 Whole House Surge Protection Device

BAD WOLF LLC
(813) 434-0404

WWW.BADWOLFUSA.COM
SALES@BADWOLFUSA.COM

WARNING SHOCK HAZARD

Improper installation or wiring may result in injury, death and/or equipment damage.

Follow all cautions and warnings included in this instruction sheet before the installation of this surge protection device SPD. It is recommended that only licensed and trained professionals install or service this device. Use safety and protection gear when installing this device. Turn off all power to any circuit connected to or adjacent to where this surge protector will be installed. Do not open this SPD as it will void the warranty and during normal operation this device will have lethal levels of electricity present both internally and externally on the wiring.

IMPORTANT INSTALLATION INFORMATION

Pick a mounting location that will provide the shortest path for your electrical connections and avoid 90-degree angles and sharp edges. Do not perform a high potential test on this device as it will result in damage. Follow all NEC guidelines when installing this device and use in conjunction with a double pole circuit breaker (SOLD SEPERATLY). These general instructions do not cover all details, variations, and options for installation. If you require further assistance regarding your specific application or installation please contact Bad Wolf for technical support at (813) 434-0404.

INSTALLATION INSTRUCTIONS

Pre-installation

- Confirm the electrical circuit that the SPD will be connected to is a 240VAC split-phase system.
- Turn OFF the power (Typically the main breaker) to the electrical panel that the SPD will be installed into.
- Remove electrical panel cover.
- Verify that there is no power present in the electrical panel.
- Determine a safe mounting location for the surge protector making sure to follow all of the above "Important Installation Information" guideline.
- Confirm that you either have an available double pole circuit breaker or space to install one.

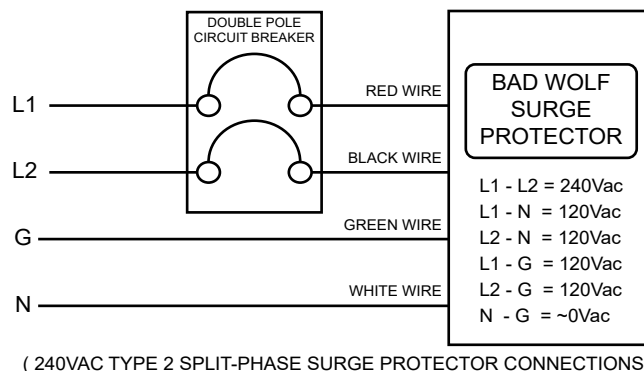



INSTALLATION INSTRUCTIONS

SPD Installation

- Install the SPD in a location that does not damage or interfere with a wire, hardware component or access.
- If your electrical panel is a “Bonded” system meaning your ground and neutral are electrically connected you may install both the White and Green wires on that same bus bar.
- If your electrical panel is a “non-Bonded” system meaning that your ground and neutral are not electrically tied together then you will need to connect the Green wire to your ground bus bar, and the White wire to your neutral bus bar.
- If you have not done so already install or make available a double pole circuit breaker (If instructions are needed follow the circuit breaker manufacturer recommended installation guide) Leave circuit breaker in the off position.
- Connect the Red line wire of the SPD to one of the terminal lugs on the circuit breaker.
- Connect the Black line wire of the SPD to the other terminal lug on the circuit breaker.
- Verify that all connections are secure.

Finish Installation

- Secure any loose wires or hardware if needed.
- Reinstall electrical panel cover.
- Restore electrical power then turn the circuit breaker on that is connected to the SPD.
- Verify that the GREEN “PROTECTED” light on the surge protector is ON meaning that it is protecting your electrical circuit. Under normal operation this should be the only light illuminated.
- If either or both of the LINE 1 or LINE 2 RED “UNPROTECTED” lights are ON then this means that the corresponding electrical circuit had a surge strong enough to damage that LINE of the surge protector.
- Register your product at www.badwolfusa.com/register/ to activate your warranty.

INSTALLATION IMAGES

